

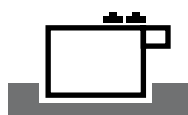

ALPHA 500

三驱动辊重型辊弯机

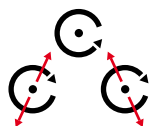















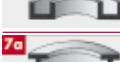

Bending machine with three driving rolls









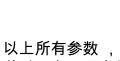





















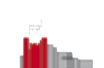

tauring
TOP PERFORMING

www.tauringroup.com

最大弯曲能力
Maximum bending capacities

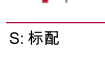
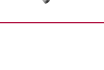
POSITION	mm	R. mm	S - O
 1a	1.000 x 150	4.800	ST/SP - SI
 1b	450 x 50 470 x 60	4.000 11.600	ST ST - SI
 2a	200 240	5.000 8.000	ST ST - SI
 3a	250 x 250 x 28	4.200	ST - SI
 3b	250 x 250 x 28	4.200	ST - SI - AIH
 6a	UPN 400	2.500	ST - SI
 6b	UPN 400	2.500	ST - SI
 6c	UPN 350 UPN 400	8.200 9.800	ST - HEH ST - HEH - SI
 7a	HEA 800 HEA 900	4.000 4.800	ST ST - SI
 7a	HEB 800 HEB 900	4.000 4.800	ST - HEH ST - HEH - SI
 7a	IPE 600 IPE 750	2.500 4.100	ST - HEH ST - HEH - SI
 7a	IPN 550	2.500	ST - SI
 7h	HEA 450 HEA 550	12.000 14.000	ST - HEH ST - HEH - SI
 7h	HEB 400 HEB 500	10.000 12.000	ST - HEH ST - HEH - SI
 7h	IPE 550 IPE 600	11.000 13.000	ST - HEH ST - HEH - SI
 7h	IPN 500 IPN 550	10.000 12.000	ST - HEH ST - HEH - SI
 9b	16" gas 18" gas	7.000 11.000	RT RT - SI
 9c	280 300	5.000 7.000	RT RT - SI
 10a	400 x 300 x 16 500 x 300 x 16	6.000 8.500	ST/RQ ST/RQ - SI
 10b	400 x 300 x 16 500 x 300 x 16	9.000 10.000	ST/RQ ST/RQ - SI
 11a	400 x 400 x 16 400 x 400 x 20	7.200 10.500	ST/RQ ST/RQ - SI

附件工具
Tools

 AIH	 RO
 S	 O
 AIC	 RQ
 O	 O
 SI	 RVT
 S	 O
 QR	 RVQ
 O	 O
 HEH	 FT
 O	 O
 ST	 FP
 S	 O
 SP	 WLC
 O	 O
 RT	 ARC 50
 O	 O

S: 标配 O: 选配

技术参数
Technical Data

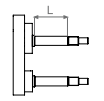
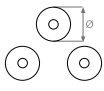
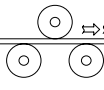
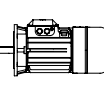
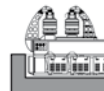
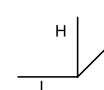
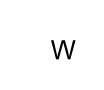
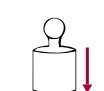
	mm 1.150
	mm 830
	min ⁻¹ 1-5,3
	kW 90
	cm 151*
	cm 415 x 580 x 425
	W L x P x H cm ³ 4.287
	kg 70.000

* 机器安放需进行地基施工
Foundation necessary

以上所有参数，可能随厂家的技术研发制造或升级换代需要随时进行修改，恕不另行通知。

Technical data, capacities and specifications are not binding and may be modified without prior notice.



经销商 / Dealer

TAURING S.p.A.
拓韧中国代表处
服务热线：400 885 0020
www.tauringgroup.com
info@tauringgroup.com.cn